



CUBIX Xpander Rack Mount 8 5U Gen 3 User Guide

Xpander Rack Mount 8 5U is a rack mount PCI Express (PCIe) expansion enclosure that enables connection of 8 double-wide graphics or other controllers with top-connected auxiliary power cables to a host computer. The host computer(s) must have at least one PCIe Gen 3.0 x16 slot available for each host interface controller (HIC).



Rack Mount 8 provides two Main Interface Boards (MIBs) connected to each of one or two host computers with a PCIe x16 cable and four PCIe x16 slots for a total of eight double-wide GPUs like NVIDIA GTX TITAN X / 980. Each MIB connects via a PCIe x16 cable to a HIC in a host computer. Connect each MIB to one of two HICs in one host or each MIB to a HIC in each of two host computers. Each MIB inside Rack Mount 8 connects to one host computer.

One host computer can support both MIBs inside the Rack Mount 8 enclosure if the host has two available PCIe x16 slots. Each MIB inside the Rack Mount 8 enclosure connects to one HIC. Rack Mount 8 provides two sets of four PCIe x16 slots for graphical processing units (GPUs), which you can use for graphical rendering, for high-performance computing (HPC) and other Compute Unified Device Architecture- (CUDA-) or OpenCL / OpenGL-enabled tasks. Rack Mount 8 can also support other PCIe adapters with multiple Input / Output (IO) ports such as FireWire, USB 3.0 or high-definition (HD) audio. See examples of configuration options at the right.

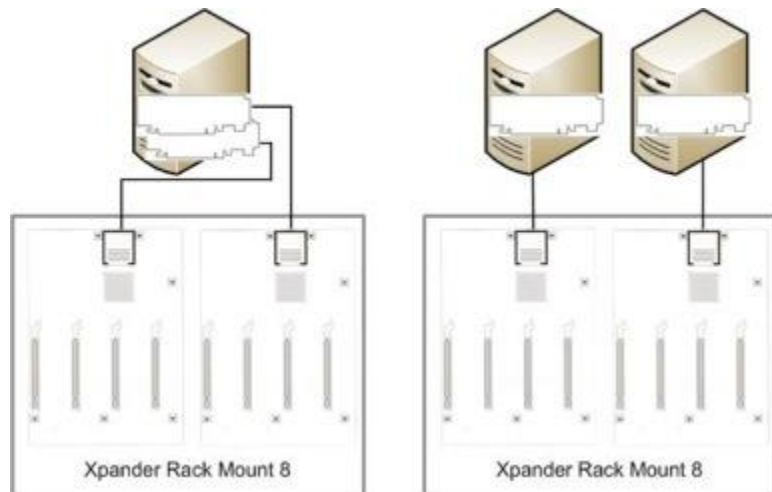

Xpander Rack Mount 8 5U Technical Specifications

Expansion slots	PCI Express Generation 3.0 x16
Number of slots (std)	4 slots in each of 2 MIBs for a total of 8 slots
Form factor support	8 full-height, full-length controllers or adapters in 2 MIBs
Auxiliary power cable support	Top-connected auxiliary power cables
	Standard: 8 x sets of 6-pin + 8-pin (6P + 8P)
	Optional: 8 x sets of 8-pin + 8-pin (8P + 8P); specify at time of order
Connecting cable	External PCI Express cable
Connector type	x16, 136-pin
Length, standard	2.00meters (78.7inches or 6.6feet) total length
	1.16meters (45.6inches or 3.8feet) usable length
Connector duty cycle	250 mating cycles maximum per connector
PCIe x16 HIC	Install in a PCIe x16 slot of the host computer
PCIe Gen 3 slot	Provides a theoretical 128.0Gbps data transfer rate
PCIe Gen 2 slot	Provides a theoretical 80.0Gbps data transfer rate
PCIe Gen 1 slot	Provides a theoretical 40.0Gbps data transfer rate
Front panel LCD	MIB select = left button
	Main menu = center button
	Sub-menu = right button (See detail on page 9.)
Cubix Corporation	MIB assembly and revision; management firmware revision
Power supply status	Standard main power; optional redundant power
Temperature status	3 sensor readouts in degrees Centigrade (C)
Fan status	Fan status, voltage percent (%) speed
PCIe link status x16 cable	x16 cable connected; 8.0Gbps, 5.0Gbps or 2.5Gbps x16 link speed
	Connected or not connected status
Slot 1 - 4 x16 transfer rate, theoretical	PCIe Gen 3.0Gbps x16 = 128.0Gbps
	PCIe Gen 25.0Gbps x16 = 80.0Gbps
	PCIe Gen 12.5Gbps x16 = 40.0Gbps
LCD panel backlight	Toggle on / off using right button
Rear panel	Power input receptacles
Adapter ports	If available, on installed controllers or adapters
Receptacle 1, right	Controls MIB 1, facing Rack Mount 8 rear (see next page)
Receptacle 2, left	Controls MIB 2, facing Rack Mount 8 rear (see next page)
Cooling fans	4 fans run at 112cfm (cubic feet per minute) maximum
Xpander power up	Fans are full on for 10s (seconds)
Fan speed, minimum	25C degrees
Fan speed, maximum	50C degrees
Fan speed, in range	25C degrees to 50C degrees in gradual, linear progression
Normal operation	D1 LED = 1 pulse of 10ms (millisecond) on for every 700ms off
Error indication	D1 LED = 4 pulses of 10ms on for every 700ms off
Error conditions	[1] No fan tachometer or [2] no temperature sensor connected
AC power supply, 2 MIBs	2 x single-phase, auto-ranging, 100-240VAC, 12.5-6.0Amps, 50/60Hz; total output power for each is not to exceed 1,500Watts each
Auxiliary power cable support	Standard: 8 x sets of 6-pin + 8-pin (6P + 8P)
	Optional: 8 x sets of 8-pin + 8-pin (8P + 8P); specify at time of order
Operating environment	0° to 30° Celsius (32° to 86° Fahrenheit) temperature 5% to 80% non-condensing humidity
Dimensions	8.75" H x 19.00" W x 28.75" D (22.23cm H x 48.26cm W x 73.02cm D)
Altitude	Maximum
Operating	10,000ft (3,050meters)
Storage	50,000ft (15,240meters)
Weight	54.00lbs (28.13kg)
Warranty / period	Parts & labor return to manufacturer / 2 year
Ext. warranty period	Optional 3 years

Included

Xpander Rackmount 8 includes four cooling fans, two 1,500W power supplies and two power cords as well as two Main Interface Boards (MIBs), two PCIe x16 HICs and two external PCIe x16 cables. It does not include installation media because installation requires no driver or other software. The only drivers you install are those for the devices you install in Xpander.

Quick Start without Detail

Install a GPU in the host system and install device drivers. Once you have verified operation, shut down, move the GPU to GPU-Xpander, install the HIC in the same slot within the host computer, connect GPU-Xpander to the HIC using the cable provided, connect power to Xpander Rackmount 8. Boot the host computer. If the host operating system (OS) is plug-n-play, the OS detects the GPUs and loads device drivers.

Start-up / Installation / Test Procedure with Detail

Each Rack Mount 8 provides two MIBs, each with four PCIe x16 slots. You can connect MIBs to HICs in one host or you can connect each MIB to a HIC in each of two hosts; however, each MIB supports only one host computer.

See the guides at the right for the receptacle that powers each MIB inside the Rack Mount 8 enclosure. Make sure you disconnect power to the appropriate MIB inside the enclosure before installing or removing GPUs.

During this procedure, place the Rack Mount 8 enclosure on a stable surface. Use a Philips #2 screwdriver for this procedure. Do not install graphics or other controllers until instructed to do so within this procedure.

1. Switch off AC power from the host computer(s). Leave the power cord to each host connected.
2. Install the standard x16 HIC in a PCIe x16 slot within the host computer.
3. Connect a power cord to each of the two receptacles (one for each MIB) at the Rack Mount 8 enclosure rear.

Xpander Rack Mount 8 Front

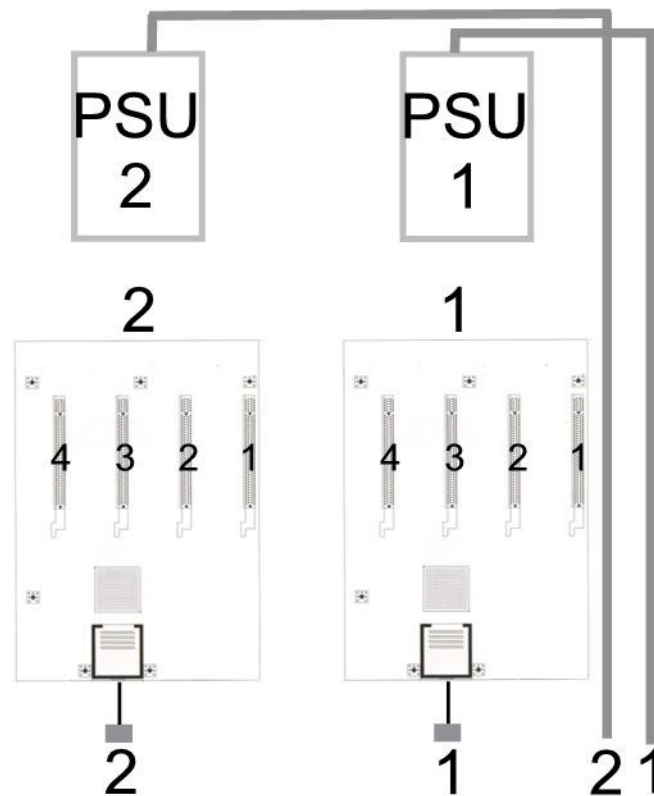

Rear Cable Connections to HICs and Power Cords

4. Connect each external PCIe cable from its MIB inside the Rack Mount 8 enclosure to each host interface controller (HIC) port. Make sure the connector snaps into place within the HIC port as shown in the illustration at the right.
5. Remove the screws holding in place the Rack Mount 8 front and middle top covers and remove both top covers.

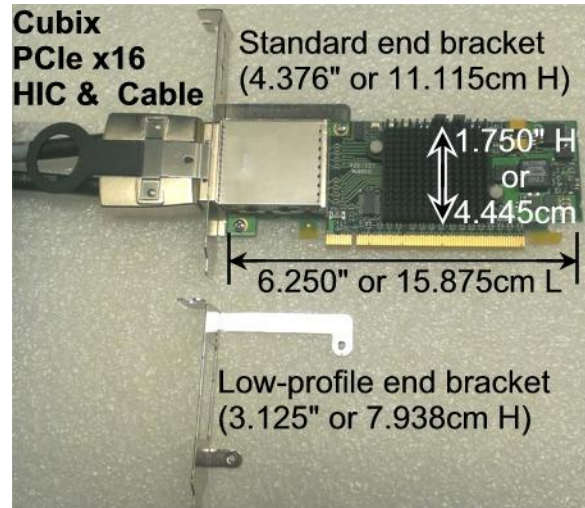

6. Connect a power cord to each of the two receptacles (one for each MIB) at the Rack Mount 8 enclosure rear.

Warning

Before installing or removing cards in the Xpander Rack Mount 8, switch off AC power and wait for the 5V Standby LED to power off.

7. Power on the host computer(s). Each corresponding MIB inside the Rack Mount 8 enclosure also powers on.

8. Confirm that the Cable Link LED (P0) lights green for each MIB inside the Rack Mount 8 enclosure.

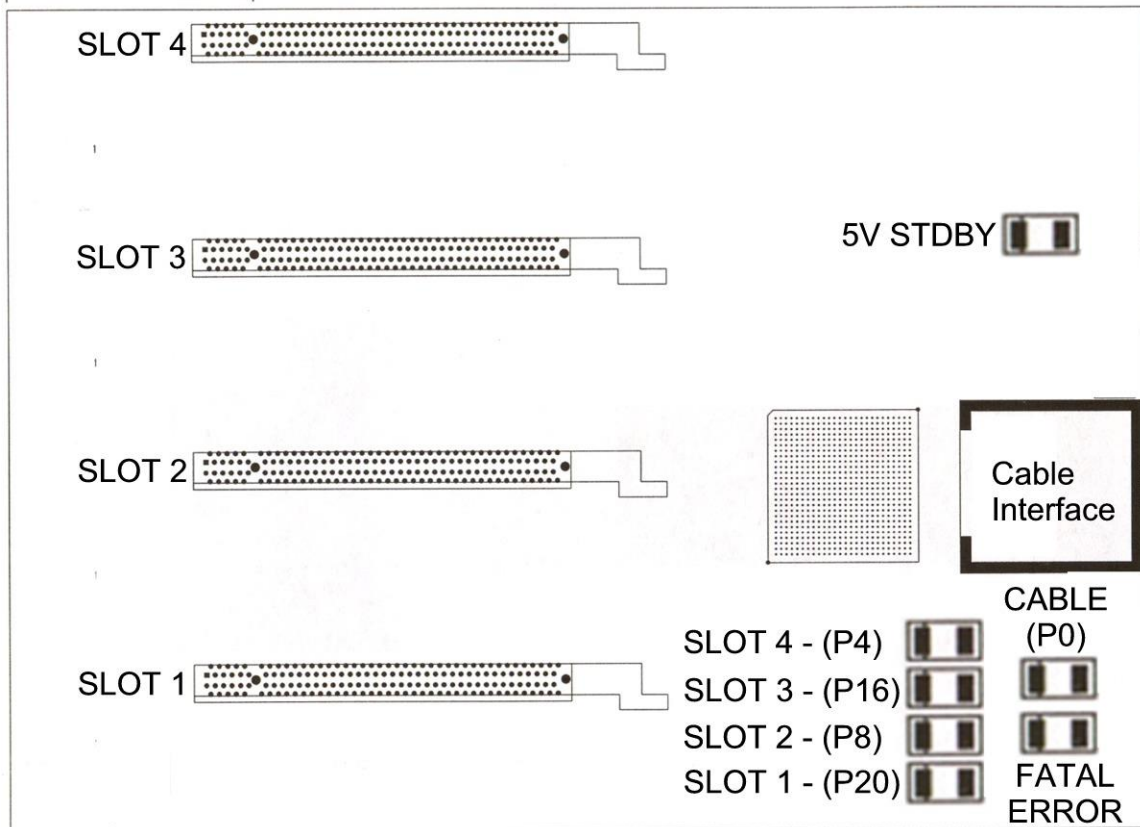

Xpander MIBs are functioning properly once each Cable LED (P0) lights green. Proceed to the next step to install adapters.

9. Switch off AC power to the host computer(s). Leave the power cords and the external PCIe cables to the host computer(s) connected.
10. Remove the two screws at each end of the rear ventilation panel above the rear Input / Output (I/O) panel, remove the ventilation panel and set it aside temporarily.
11. Remove the screws for holding down the PCIe card end brackets.
12. Install the graphics or other controller(s) in the Rack Mount 8 PCIe slot(s) and secure each with the screws provided in the top of the I/O panel.

13. Connect PCIe auxiliary (aux) power cables. Each MIB inside Rack Mount 8 enclosure provides four sets of aux power connectors including 6P + 8P (6-pin and 8-pin) connectors. See the image at the right.
14. Make sure blank end brackets (L-brackets) are installed for each slot without a device, especially if it is a passively-cooled GPU.



Warning

Make sure that blank end brackets (L-brackets) are installed for each slot that has no PCIe card, especially if the installed cards are passively-cooled GPUs. Blank end brackets are required to assure proper cooling of the GPUs.

15. Connect GPU video port(s), if present, to monitors. This step is especially important for Linux, because X Windows will crash if you have not connected video ports to monitors. If you cannot connect monitors to installed GPU video ports, you can edit the Device section of /etc/X11/xorg.conf to define which GPU X Windows should use as the primary display device. For example:

```
Section "Device"
    Identifier      "Device0"
    Driver          "nvidia"
    VendorName     "NVIDIA Corporation"
    BoardName      "GeForce GTX 980"
    BusID          "PCI:8:0:0"
EndSection
```

To determine the BusID for the GPU you wish to use as the primary display, run the scanpci tool discussed in Step 17.

16. Power up the computer(s) and the Rack Mount 8 to confirm that the appropriate slot link LEDs are lit green, which confirms that you have installed a controller correctly in each slot. Refer to the appropriate image above to identify slot LEDs.
17. Confirm that your operating system (OS) has detected the new controller(s). For instance, in a PC running Microsoft® Windows®, check Windows Device Manager. Within Windows, you can also run GPU-Z, a utility available for free download [here](#). In a PC running Linux, run the following:

```
root# > XFree86 -scanpci
```

Read more about scanpci [here](#).

18. Connect power to Xpander and boot up the host computer. Install the appropriate graphics or other controller driver(s) using the vendor's procedure: e.g., NVIDIA GTX TITAN X / 980.
19. Replace the Rack Mount 8 front top covers and replace the screws holding it in place.

Warning

Replace the cover as soon as possible to allow for proper cooling. Do not run Rack Mount 8 without the cover for more than a few minutes.

Normal Power On/Off Procedure

1. With Rack Mount 8 connected to the host computer(s) and running, shut down the host computer(s) normally.
2. With Rack Mount 8 connected to the host computer(s) and powered down, switch on the connected host computer(s); both will boot up.
3. To run the host PC or Mac Pro without Xpander connected, power down the host, remove power from Xpander and boot the host. When you are ready to run Xpander again, power down the host, connect power to Xpander and boot the host.

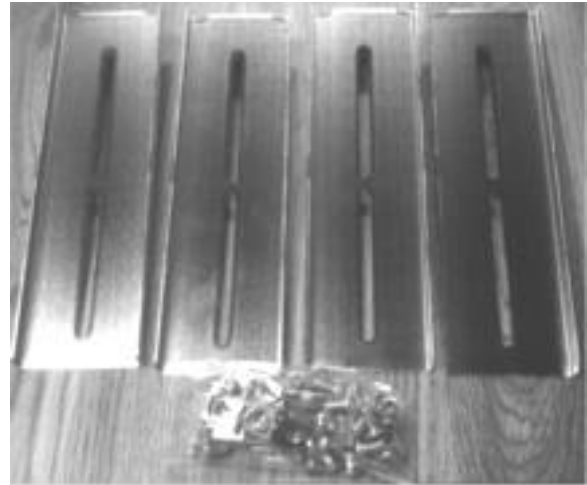

Cubix ships the mounting brackets, G-nuts and screws within the package.

Install Xpander in a Cabinet

For this procedure, use a Philips #2 screwdriver, a flat-blade screwdriver and a 3/8" wrench or socket and drive. When lifting the Xpander into place, ask for assistance. Mount it close enough to the host computer so that the external PCIe cable will reach. Mount Xpander either immediately above or immediately below the host computer(s) in the cabinet.

Within packaging, you will find four brackets that mount within the four corners of your rack mount cabinet, screws, nuts and G-nuts for use in mounting Xpander within a cabinet. See the image on the previous page.

1. Shut down the host and Xpander normally and disconnect all data and power cables connected to Xpander.
2. Find in packaging the rackmount slide rails with a bag of 8 x mounting screws taped to one of the rails.

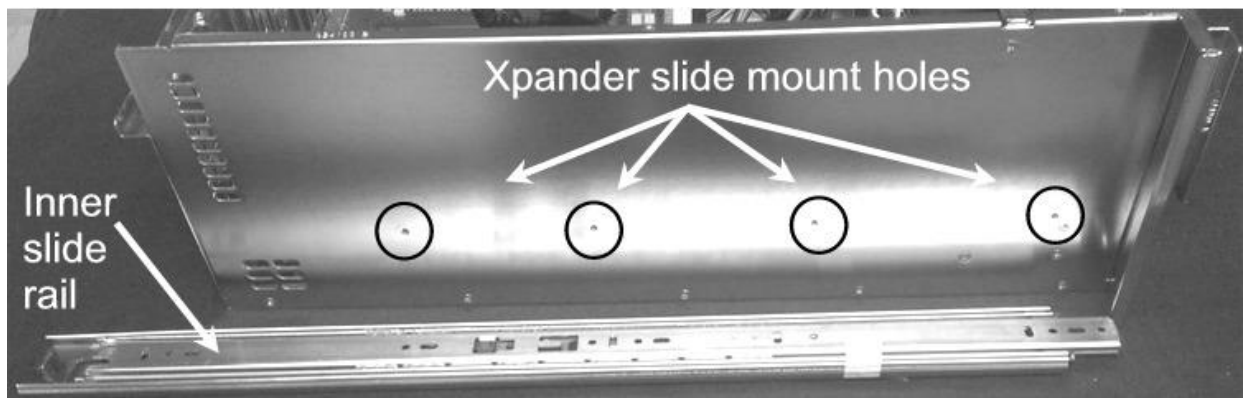

3. Remove the inner slide rail, or slide mount, from the outer rail and mount it to Xpander using the Xpander slide mounting holes. To release each outer slide mount, slide it toward the rear of the enclosure until it stops. Press the catch to release and remove the

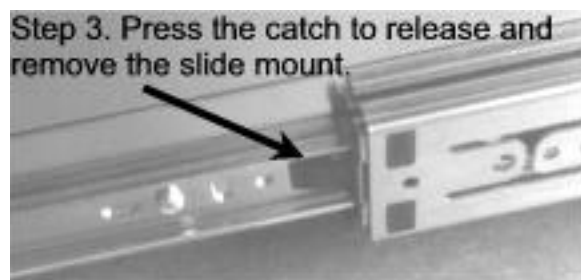

outer slide mount as you can see in the image at the right.

4. Determine where to mount the Xpander slide mounts in your cabinet.
5. Mount the front and rear mounting brackets (Part # S32760A) to each slider assembly with the bolts and nuts provided in the packaging.
6. Repeat the process for the other front and two rear mounting brackets and slider assembly.
7. Tightly secure the screws holding the sliders to the front and two rear mounting brackets on each side of the cabinet.
8. Check the two rails on each side and check from front to rear to make sure that you have mounted the rails so that they are level within the cabinet.
9. Lift the Xpander, line up the inside slider with the slider assembly mounted in your cabinet and carefully slide it into place.

Warning

Before lifting Xpander into place, ask for assistance.

10. Try sliding the Xpander in and out slightly to make sure it moves freely.
11. Secure Xpander into place within the cabinet using the front-panel screws provided.
12. Connect the PCIe x16 external cable to the HIC in the host computer.
13. Connect power to Xpander.

Use this step if you need extender brackets for mounting in a 1000mm deep cabinet.

14. Mount the extender bracket on the outer slide mount behind the front bracket (S32760 A). Mount the rear bracket (S32760 A) to the rear end of the extender bracket. Leave the nuts loose so you can slide the rear bracket along the extension bracket to mount on the cabinet's vertical rails and fit inside the cabinet. Check to make sure the mounting brackets and slide rails are level from front to rear before tightening the screws and nuts. Align the front of the slider with the front of the cabinet.



Attach the extender rail (S31096 A) on the outer slide mount behind the front bracket (S32760 A). Mount the rear bracket (S32760 A) on the extender rail. Leave the nuts snug but not tight so you can slide the rear bracket along the extension rail to fit in the cabinet.

15. If you do not need the extender brackets, mount each of the two sliders into the front and rear mounting brackets (Part # S18500A) and slider assembly with the bolts and G-nuts provided in the packaging. Use the Philips #2 screwdriver and the 3/8" wrench or socket to secure snugly but not tightly each slider to the front and rear mounting brackets. Check to make sure the mounting brackets and slide rails are level from front to rear before tightening the screws and nuts. Align the front of the slider with the front of the cabinet.

16. Repeat the process for the other two front and two rear mounting brackets (as well as the extender bracket if needed) and slider assembly on the right side of the cabinet.
17. Check to make sure that the slide rails are level, both from front to back and from right to left. Once you're sure the slide rails are level, you're ready to tighten the mounting screws. See the image at the right.



Step 8. Mount the slide rails on the mounting brackets (inside view).

18. Tightly secure the screws holding the sliders to the front and two rear mounting brackets on each side of the cabinet.
19. Extend the slide rails almost all the way out the front of the cabinet.

20. Lift the Rack Mount 8 enclosure, line it up carefully and slide it into place. Before lifting the Rack Mount 8 enclosure into place, ask for assistance.
21. Try sliding the Rack Mount 8 in and out slightly to make sure it moves freely.
22. Connect the AC power cords into the Rack Mount 8 rear receptacles.
23. Make sure the host computer(s) with the host adapters installed are powered down.
24. Connect the PCIe x8 or x16 external cables to the host adapters in the host computer(s).
25. Power up the host computer(s) with the host adapters installed.

Access the Xpander Rack Mount 8 Interior

For this procedure, use a Philips #2 screwdriver. For accessing Rack Mount 8 to add, move or replace GPUs or other adapters, use the following procedure.

1. Shut down gracefully the host computer(s) connected to the MIB(s) you intend to access.
2. Remove the power cord(s) connected to the MIB(s) you intend to access.
3. Remove the secure screws holding the Rack Mount 8 in the cabinet.
4. Gently pull the Rack Mount 8 toward you a foot or so.
5. Remove the four screws (front, rear and one on each side) holding in place the Rack Mount 8 front top covers, remove the top covers and set them aside.
6. Remove the four screws holding the ventilation panel in place above the I/O panel.

Warning

Before installing or removing cards in the Rack Mount 8, switch off AC power and wait for the 5V Standby LED to power off for the affected MIB.

7. Add, remove or replace the GPUs or other cards, making sure to seat each firmly in the slot, secure the end bracket screws and to connect aux power cables, if necessary.

Warning

Make sure that blank end brackets (L-brackets) are installed for each slot that has no PCIe card, especially if the installed cards are passively-cooled GPUs. Blank end brackets are required to assure proper cooling of the GPUs.

8. Replace the Rack Mount 8 front top cover and replace the four screws (front, rear and one on each side) holding it in place.
9. Gently slide the Xpander Rack Mount 8 back in place.
10. Replace the secure screws holding the Rack Mount 8 in the cabinet.

Front Panel LCD

Rackmount 8 front panel LCD provides enclosure details and status. Beneath the LCD are three buttons: left button selects MIB, middle button scrolls through main-menu items and right button scrolls through sub-menu items.

When you first connect power, Xpander comes up in standby mode. The LCD displays Cubix on the top line and Corporation on the bottom line. This is the Start menu. Access all other main menu items



by pressing the left button for a MIB, the middle button for a menu selection and then the right button for a sub-menu selection.

The upper right corner of the LCD shows a flashing asterisk *. This indicates that the on-board Micro-Controller Unit (MCU) is running properly. If the asterisk is not flashing or the LCD is not responding, reset the MCU by pressing and holding the left button for 3 seconds while Xpander is running. A corresponding HB (for heartbeat) LED on the MIB also shows the MCU is working.

When a fault occurs, the LCD will jump to that fault and the LCD backlight will flash on / off. Press the left button to acknowledge the fault and the LCD will stop flashing and enable normal operation. The LCD will continue to display the fault at the applicable sub-menu until you clear the fault.

Start Menu

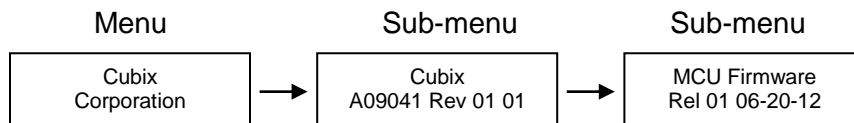

Main menu: Cubix Corporation

Sub-menu: PCB Assembly

- Board Number
- EEPROM Revision
- Board Revision

Sub-menu: PCB Assembly

- Serial Number

Sub-menu: MCU Firmware

- Release Number
- Release Date

Power Supply Status

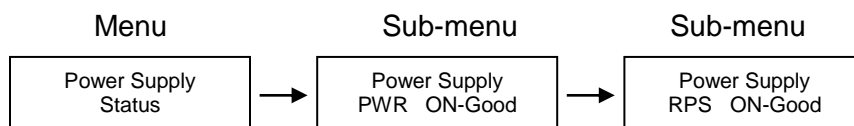

Menu: Power Supply Status

Sub-Menu: Power Supply Status:

- PWR Standby = Main power is off; system is in standby
- PWR ON-Good = Main power is on; +3.3V, +5V, +12, -12V are within spec.
- PWR ON-FAULT = Main power is on; +3.3V, +5V, +12V, or -12V is out of spec.

Sub-Menu: Optional redundant power supply (RPS) status

- RPS Standby
- RPS ON-Good
- RPS ON-FAULT

Temperature Status

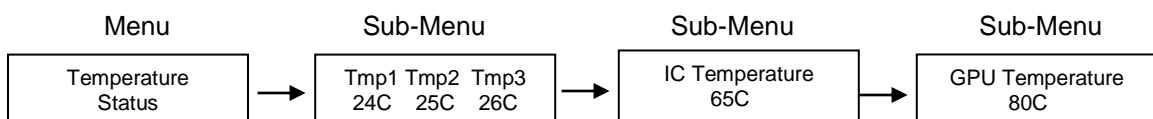

Menu 3: Temperature Status
 Sub-Menu: Display the temperature of the 3 temperature sensors in degree Celsius.
 In event of a temperature sensor failure, "FLT" is displayed under the failed sensor.
 Sub-Menu 2: PEX8780 IC Temperature (Range: 20C-125C, ---C when power is off)
 Sub-Menu 3: GPU (highest GPU temperature of installed Xpander GPUs, ---C when power is off)

Fan Status

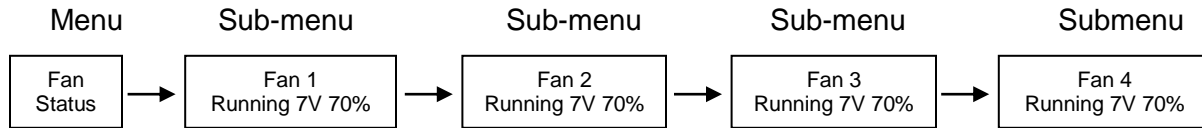

Menu: Fan Status
 Sub-Menu: Indicates fan status for fans 1-4
 Note: Fan speed is controlled by adjusting fan voltage based on sensed system temperature. Fan voltage adjusts from 6V min (25deg C or lower) at 50% to 12V max (50deg C or higher) at 100%. Fan voltage is the same for all fans.

- PWR OFF is 0V at 00%; system is in standby.
- Running aaV at pp%; fan is good; aa = fan voltage and pp = fan power percent (%).
- STOPPED is 12V at 100%; fan fault: fan voltage is set to full on.
- No fan is aaV at pp%; Xpander can be configured with 1, 2, 3, or 4 fans. No fan means fan is not installed.

PCIe Link Status

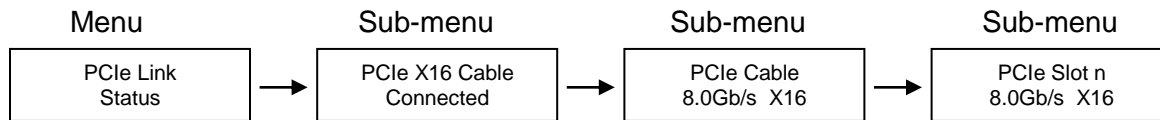

Menu: PCIe Link Status
 Sub-Menu: Indicates x16 PCIe cable installation status

- Connected x16 cable is properly connected to the HIC
- NOT-Connected x16 cable is not properly connected to the HIC

Sub-Menu: x16 PCIe cable link speed and link width. Speed and width depend on the host capability.

- Speed: 8.0Gb/s, 5.0Gb/s or 2.5Gb/s
- Width: x1, x2, x4, x8, x16 and "NO Link" when the host did not successfully link or Xpander is in standby power.

Sub-Menu: Link speed and link width for slots 1-6.

- Speed: 8.0Gb/s, 5.0Gb/s or 2.5Gb/s
- Slot 1-8 width: x1, x2, x4, x8, x16 and "NO Link" when the slot is empty, unsuccessful link, or Xpander is in standby power.

LCD Backlight Control

Press right switch to toggle the LCD backlight On/Off.

Fan Speed Control

Shunts JP7 and JP8 are used to change the fan profile to reduce fan noise. For both JP7 and JP8, pin 1 is farthest from the board edge and pin 3 is closest to the board edge.

Fan Profile	JP7	JP8	*Tmax	*Tmin
Performance Mode	1-2	1-2	55C	20C
Quiet Mode	1-2	2-3	65C	30C
High Performance Mode	2-3	1-2	40C	5C
**GPU Mode	2-3	2-3	80C/40C	45C/5C

* Tmax - Fan Voltage ~12V, Tmin - Fan Voltage ~6V

**GPU Mode: Tmax: GPU temp = 80C, if no GPU is found Tmax = 40C (on-board temp sensors)
Tmin: GPU temp = 45C, if no GPU is found Tmin = 5C (on-board temp sensors)
GPUs supported: Quadro K6000, M6000 and P6000

Fan Profile Guidelines. GPU Mode supports 4 x double-wide GPUs like NVIDIA Quadro or GTX Series. High-Performance Mode supports 2 – 3 double-wide GPUs. Performance Mode supports 2 x double-wide GPUs. Quiet Mode supports 1 x double-wide GPU or 4 x single-wide GPUs. See Technical Specifications on page 2.

Shipping Procedure

Before shipping Xpander, remove any installed graphics or other controller(s) using the following procedure:

1. Switch off the host computer connected to Xpander.
2. Disconnect Xpander from the HIC(s).
3. Remove the secure screws holding the Xpander in the cabinet.
4. Gently pull the Xpander toward you.
5. Lift Xpander down from the cabinet and set it on a stable surface.

Warning

Before lifting Xpander out of a cabinet, ask for assistance.

6. Remove the screws holding Xpander top cover, remove it and set it aside.
7. Remove the graphics or other controllers and pack them in the original packaging.

Warning

Remove GPUs or other adapters before shipping Xpander.

8. Replace the hold-down brackets and tighten the captured screws.
9. Pack the graphics cards or other controllers within the boxes in which you received them.
10. Replace the Xpander Rackmount Elite front top cover, replace the screws and remove the power cords.
11. Remove the two outer slide mounts by sliding each out until it stops. Press the catch to release and remove the outer slide mount.
12. Remove the two slide mounts from the Xpander sides.
13. Store all the screws, nuts and G-nuts in the plastic bag included. Tape the bag to the rails and wrap the rails together.
14. Remove the HIC(s) from the host computer.
15. Within the original packaging, pack the Xpander, the power cords, the HIC(s) and the boxed graphics cards. Include a copy of these instructions.

Troubleshooting Procedure

- Issue:** Cable LED inside Xpander does not light green.
Resolution: Check the following:
- Confirm that the HIC is firmly seated in a PCIe slot within the host computer.
 - Confirm that the cable connector is firmly seated HIC connector port.
- Issue:** Cable LED inside Xpander flashes green even though I have a PCIe x16 HIC and cable.
Resolution: The internal Cable LED should light steady green. If the Cable LED flashes, it is transferring data at a reduced bandwidth because you installed the PCIe x16 HIC in a Gen 1 slot or a PCIe x8 (electrical) slot. If your HIC is PCIe x8, you installed it in a Gen 1 slot. The HIC operates at full bandwidth when installed in a PCIe Gen 2 slot.
- Issue:** Slot LED inside Xpander does not light green.
Resolution: Shut down the OS gracefully, power down Xpander and reseal the GPUs in each PCIe slot. Make sure that you seat each GPU firmly in its slot and that you connect all aux power connectors firmly.
- Issue:** Slot LED inside Xpander flashes green even though I installed a PCIe x16 Gen 3 GPU or card.
Resolution: Slot LEDs should light steady green. If they are flashing, it may be because the GPUs in the slots do not have a processing load. Apply a processing load on the GPUs. If the slot LEDs still flash green, check the vendor's link for a driver update.
- Issue:** All Cable and Slot LEDs are lit green but your OS does not detect the GPUs.
Resolution: Shut down the OS gracefully, power down Xpander and reseal the GPUs in each PCIe slot. Make sure that you seat each GPU firmly in its slot and that you connect all aux power connectors firmly.
- Issue:** The front-panel LCD screen backlight is flashing on/off, which indicates a fault.
Resolution: Press the MIB button momentarily to identify the MIB with the fault. Acknowledge the fault by pressing the Menu button, which will stop the LCD flashing and the LCD will remain at the fault.
- Issue:** After acknowledging a fault, the front-panel LCD screen backlight continues flashing on/off, which indicates two or more faults. If multiple faults have occurred, when you acknowledge the first fault, the LCD will jump to the next fault and the LCD backlight will once again flash on/off. This continues until you clear all faults.
Resolution: Press the MIB button momentarily to identify the MIB with the fault. Acknowledge the fault by pressing the Menu button, which will either stop the LCD flashing and the LCD will remain at the fault, or the LCD will jump to the next fault and the LCD backlight will once again flash on/off.
- Issue:** The front-panel LCD screen either does not respond or is blank even though Xpander is operating.
Resolution: Press and hold the MIB Select button to reset the Micro-Controller Unit (MCU).

Issue: The front-panel LCD screen either does not respond or is blank for a particular MIB even though Xpander and the MIB are both operating.

Resolution: Select the appropriate MIB using the MIB Select (left) button. Press and hold the Menu (middle) button for 3 seconds to reset the Micro-Controller Unit (MCU). If the Xpander is running, the Xpander fans will turn on full speed for 10 seconds and then slow down to the operating speed set by the MIB local temperatures.