



CUBIX

Xpander Rack Mount 2 Gen 3 User Guide

Xpander Rack Mount 2 is a 2U rack mount PCI Express (PCIe) expansion enclosure that enables connection of graphics or other controllers to a host computer. The host must have a PCIe x16 expansion slot available for the host interface controller (HIC). Rack Mount 2 provides two PCIe x16 slots. Connect a HIC in one host computer to one Xpander.



With a HIC installed, a single host computer can support two double-wide graphical processing units (GPUs) inside one Xpander. It connects to one HIC. Rack Mount 2 provides two PCIe Generation 3 (Gen 3) x16 slots for GPUs or other PCIe adapters with multiple Input / Output (I/O) ports such as FireWire, USB 2.0, or high-definition (HD) audio. For example, use NVIDIA Compute Unified Device Architecture (CUDA) -enabled GPUs for rendering, high-performance computing (HPC) or HPC visualization.

A HIC in a host computer's PCIe Gen 3.0 x16 slot provides the full connection transfer rate with Xpander. For example, the HIC in a PCIe Gen 3.0 x16 slot provides a theoretical transfer rate of 8.0Gbps x16 = 128Gbps.

Xpander Rack Mount 2 Gen 3 Technical Specifications

Expansion slots, x16 std	PCI Express Gen 3.0 x16 mechanical / electrical
Number of slots	2 slots in one mainboard
Form factor support	2 double-wide, full-length, full-height controllers / adapters
Connecting cable	External PCI Express x16, 136-pin cable
Cable / connector	x16 / 136-pin
Length, standard	2.00meters (78.74inches or 6.56feet)
Length, optional	1.00meter (39.37inches or 3.28feet)
Connector duty cycle	250 mating cycles maximum per connector
PCIe x16 HIC	Host interface controller, install in a PCIe x16 slot
PCIe Gen 3.0 slot	Provides a theoretical 128Gbps data transfer rate
PCIe Gen 2.0 slot	Provides a theoretical 80Gbps data transfer rate
PCIe Gen 1.0 slot	Provides a theoretical 40Gbps data transfer rate
Front panel LCD	Main menu = left button; sub-menu = right button
Cubix Corporation	MIB assembly and revision; management firmware revision
Power supply status	Standard main power
Temperature status	3 sensor readouts in degrees Centigrade (C)
Fan status	Fan status, voltage percent (%) speed
PCIe link status	x16 cable connected; 8.0Gbps x16 link speed
x16 cable	Connected or not connected status

Slot 1 - 2 x16 transfer rate, theoretical	PCIe Gen 3.0, 8.0Gbps x16 = 128.0Gbps PCIe Gen 2.0, 5.0Gbps x16 = 80.0Gbps PCIe Gen 1.0, 2.5Gbps x16 = 40.0Gbps
Rear panel	1 power input receptacle and 1 x PCIe x16 cable receptacle
Cooling fans	2 x fans run at 90cfm (cubic feet per minute) maximum
Air flow direction	Front to rear
Xpander power up	Fan is full on for 10s (seconds)
Fan speed, minimum	50% (6Volts) at 25 degrees C or less
Fan speed, maximum	100% (12Volts) at 50 degrees C or more
Fan speed, range	25 degrees C to 50 degrees C in gradual, linear progression
Normal operation	D1 LED = 1 pulse of 10ms (millisecond) on for every 700ms off
Error indication	D1 LED = 4 pulses of 10ms on for every 700ms off
Error conditions	[1] No fan tachometer or [2] no temperature sensor connected
AC power supply	Single-phase, auto-ranging, 100 - 240VAC, 9.5 - 4.5Amps, 50 / 60Hz; total output power is not to exceed 800Watts
Operating environment	0° to 30° Celsius (32° to 86° Fahrenheit) temperature 5% to 80% non-condensing humidity
Dimensions (2U)	3.50" H x 19.00" W x 16.00" D (8.89cm H x 48.26cm W x 40.64cm D)
Weight	18.50lbs (8.39kg) with no GPUs
Warranty / period	Parts & labor return to manufacturer / 2 years
Ext. warranty period	Optional 3 years

Included

Rack Mount 2 includes two cooling fans, a 800W power supply and a power cord as well as one 2-slot mainboard with risers, one PCIe x16 HIC and one external PCIe x16 cable. It does not include installation media because installation requires no driver or other software. The only drivers you install are those for the devices you install. Cubix provides a standard, two-year warranty with the purchase of each Rack Mount 2.

Optional

The standard external PCIe cable length is 2meter. Optional 1m PCIe cable is also available. The maximum duty cycle for PCIe cables is 250 mating cycles. Cubix offers a third-year warranty option on Xpander products for a total of three years.

Quick Start Without Detail

Install a GPU in the host system and install device drivers. Once you have verified operation, shut down, move the GPU to Xpander, install the HIC in the same slot within the host computer, connect Xpander to the HIC using the cable provided, connect power to Xpander Rack Mount 2. Boot the host computer. If the host operating system (OS) is plug-n-play, the OS detects the hardware devices and loads device drivers.

Start-up / Test / Installation Procedure With Detail

Check your host computer motherboard vendor's Website for device driver and firmware updates, especially those that may affect multiple GPUs. During this procedure, place the Rack Mount 2 on a stable surface. Use a Philips #2 screwdriver for this procedure. Do not install graphics or other controllers until instructed to do so within this procedure. Cubix recommends that you do not install your first Rack Mount 2 enclosure in the rack mount cabinet until you have finished.

1. Switch off AC power to the host computer. Leave the power cord connected.
2. Switch off AC power to Xpander Rack Mount 2.

3. Install the x16 HIC in a PCIe x16 slot within the host computer.
4. Remove the screws holding in place the Xpander top cover, remove the top cover and set it aside.
5. Connect the external PCIe cable from the Xpander to the HIC in the host computer. Make sure the cable connector seats firmly in the HIC port. You will feel the cable connector click into place. See the image of a properly-seated connector at the right.
6. Connect a power cord to the receptacle at the Xpander enclosure rear.
7. Power on the host computer. Xpander also powers on. If you have properly seated the HIC in the host PCIe slot, you will see the 8 LEDs at the top edge of the HIC light steady green.
8. Check the mainboard Cable (P0) LED, which should light steady green. This indicates that the connection between the HIC and Xpander mainboard is good. The 5VSTBY LED should also light steady green. See the image at the top of the next page.



Confirm that interior Cable LED (P0) is lit green. The unit fans are spinning.

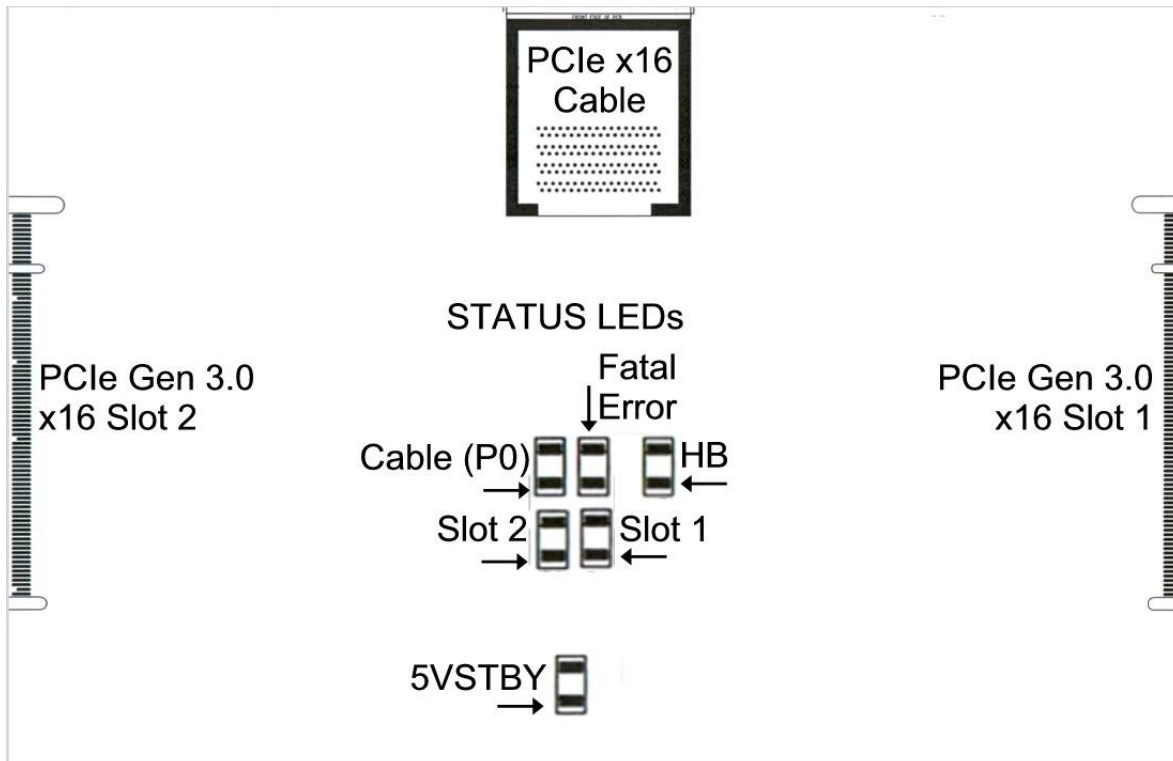

Xpander is functioning properly once the Cable LED (P0) lights green. Proceed to install adapters.

9. Switch off AC power to the host computer. Leave the power cord and the external PCIe cable to the host computer connected.
10. Switch off power and remove the power cord from Xpander.

Warning

Before installing or removing cards in Xpander, switch off AC power and wait for the mainboard 5V Standby LED to power off.

11. Remove the two screws holding the end-bracket retaining panel from Xpander rear and remove the retaining panel. See the image below.

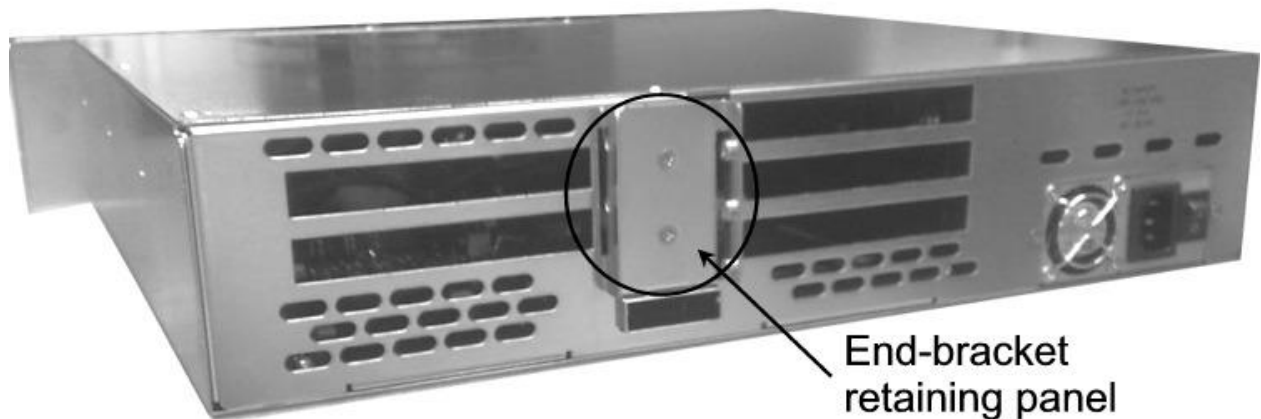

12. Install the GPUs and the Quadro Sync (QSync) card, if applicable, in the appropriate riser slots.
13. Install blank end-brackets, if required. Find 3 x blank end-brackets in the Xpander packaging.

13. Connect PCIe auxiliary (aux) power cables to the GPUs and the QSync card, if applicable. Aux power connectors are located at the rear of each GPU or other QSync card. Rack Mount 2 provides two sets of 2 x 6-pin auxiliary power connectors. Xpander also provides 1 x SATA auxiliary power cable for the QSync card. See the image of auxiliary power connectors below.

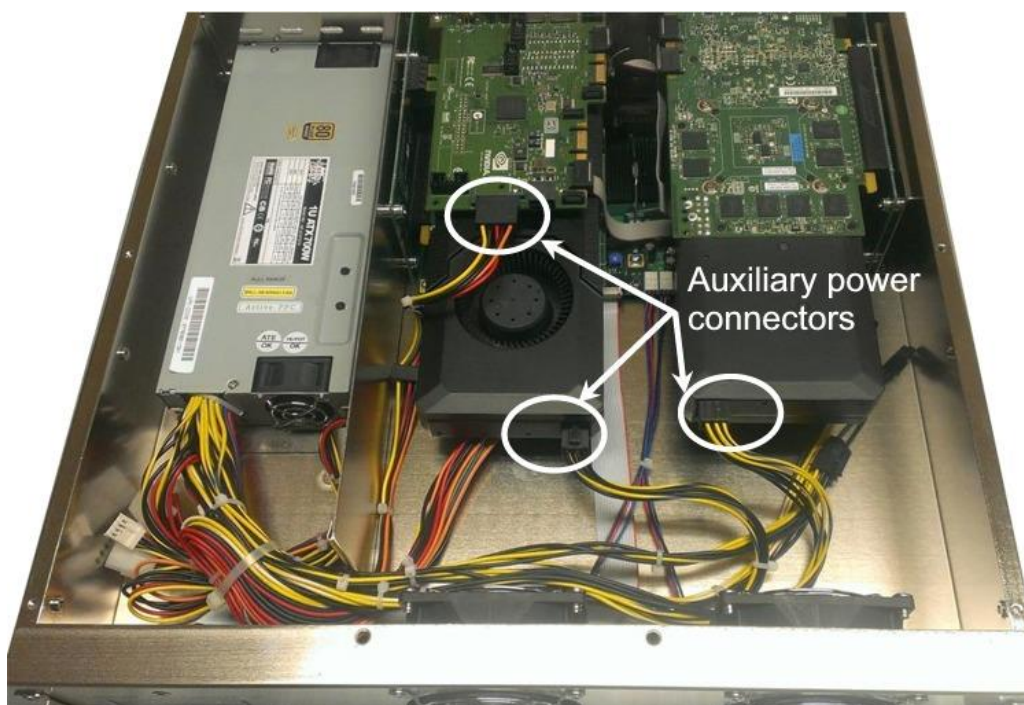

14. Replace the two screws holding the end-bracket retaining panel on Xpander rear.
15. Install the hex-head screws that seat the end-brackets in place.
16. Connect GPU video port(s), if needed, to monitors. This step is especially important for Linux, because X Windows crashes if you have not connected video ports to monitors. If you cannot connect monitors to installed GPU video ports, you can edit the Device section of /etc/X11/xorg.conf to define which GPU X Windows should use as the primary display device. For example:

```

Section "Device"
    Identifier      "Device0"
    Driver          "nvidia"
    VendorName     "NVIDIA Corporation"
    BoardName      "Quadro M6000"
    BusID          "PCI:8:0:0"
EndSection

```

To determine the BusID for the GPU you wish to use as the primary display, run the scanpci tool discussed in Step 19.

17. Install the single-wide cards at the far right facing the rear of Xpander.
18. Power up the host computer and Xpander to confirm that the appropriate Xpander slot link LEDs are lit green, which confirms that you have installed the controller(s) correctly in each slot.

Note

Slot LEDs should light steady green. If they are flashing, it may be because the GPUs in the slots do not have a processing load. Apply a processing load on the GPUs. If the slot LEDs still flash green, check the vendor's link for a driver update.

19. Confirm that your operating system (OS) has detected the new controller(s). For instance, in a PC running Microsoft® Windows®, check Windows Device Manager. Within Windows, you can also run GPU-Z, a utility available for free download [here](#). In a PC running Linux, run the following:

```
root# > XFree86 -scanpci
```

Read more about scanpci [here](#).

20. If all the Cable Link and slot LEDs are lit green but your OS does not detect the GPUs, shut down the OS gracefully, power down Xpander and reseal the GPUs in each PCIe slot. Make sure that you seat each GPU firmly in its slot and that you seat all aux power connectors firmly.
21. Power up the host computer and Xpander.
22. Install the appropriate graphics or other controller driver(s) using the vendor's procedure.
23. Replace the Xpander front top cover and replace the screws.

Warning

Replace the cover as soon as possible to allow for proper cooling. Do not run Xpander without the cover for more than a few minutes.

Normal Power On/Off Procedure

1. With Xpander connected to the host computer and running, shut down the host normally.
2. With Xpander connected to the host computer and with power connected to both, switch on Xpander first. Switch on the connected host computer; both will boot.

Install Xpander in a Cabinet

For this procedure, use a Philips #2 screwdriver, a flat-blade screwdriver and a 3/8" wrench or socket and drive. When lifting the Xpander into place, ask for assistance. Mount it close enough to the host computer so that the external PCIe cable will reach. Mount Xpander either immediately above or immediately below the host computer(s) in the cabinet.

Within packaging, you will find four brackets that mount within the four corners of your rack mount cabinet, screws, nuts and G-nuts for use in mounting Xpander within a cabinet. See the image at the right.



Cubix ships the mounting brackets, G-nuts and screws within the package.

1. Shut down the host and Xpander normally and disconnect all data and power cables connected to Xpander.
2. Find in packaging the rackmount slide rails with a bag of 8 x mounting screws taped to one of the rails.

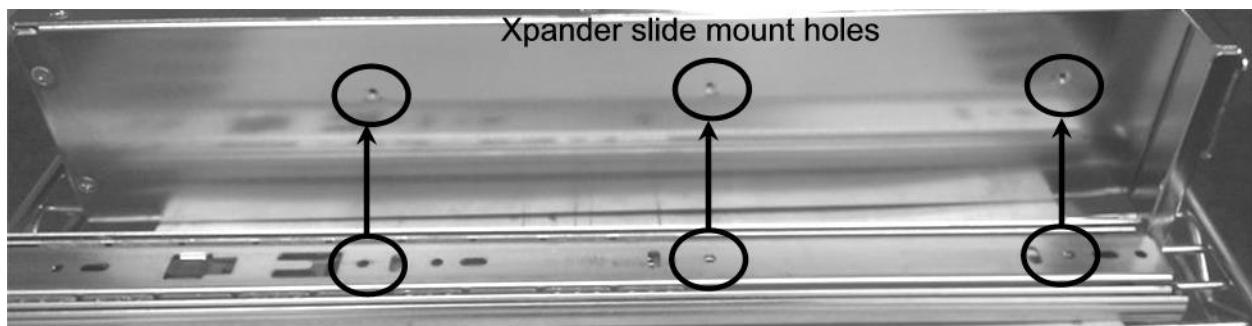

3. Remove the inner slide rail, or slide mount, from the outer rail and mount it to Xpander using the Xpander slide mounting holes. To release each outer slide mount, slide it toward the rear of the enclosure until it stops. Press the catch to release and remove the outer slide mount as you can see in the image at the right.
4. Determine where to mount the Xpander slide mounts in your cabinet.
5. Mount the front and rear mounting brackets (Part # S32760A) to each slider assembly with the bolts and nuts provided in the packaging.
6. Repeat the process for the other front and two rear mounting brackets and slider assembly.
7. Tightly secure the screws holding the sliders to the front and two rear mounting brackets on each side of the cabinet.
8. Check the two rails on each side and check from front to rear to make sure that you have mounted the rails so that they are level within the cabinet.

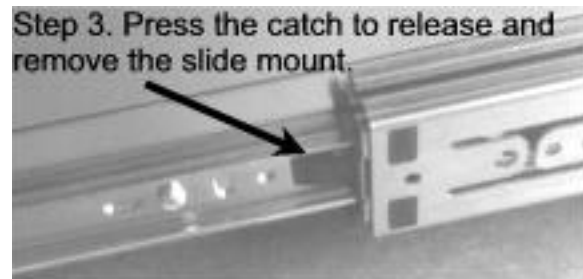

- Lift the Xpander, line up the inside slider with the slider assembly mounted in your cabinet and carefully slide it into place.

Warning

Before lifting Xpander into place, request assistance.

- Try sliding the Xpander in and out slightly to make sure it moves freely.
- Secure Xpander into place within the cabinet using the front-panel screws provided. Use the Philips #2 screwdriver.
- Connect the PCIe x16 external cable to the HIC in the host computer.
- Connect power to Xpander.

Access Rack Mount 2 Interior

For this procedure, use a Philips #2 screwdriver. For accessing Xpander to add, move or replace GPUs or other adapters, use the following procedure.

- Shut down gracefully the host computer connected to Xpander.
- Switch off power and disconnect the power cord.
- Remove the two front-panel screws that secure Rack Mount 2 to the rackmount cabinet.
- Gently pull the Xpander toward you.
- Remove the screws holding in place the Xpander front top cover, remove the top cover and set it aside.
- Make sure the 5V Standby LED in Xpander is off.

Warning

Before installing or removing cards from GPU-Xpander, switch off AC power and wait for the 5V Standby LED to power off.

- Remove the screws holding each of the end-brackets.
- Remove the two screws holding the end-bracket retaining panel from Xpander rear and remove the retaining panel.
- Remove and replace the GPUs or other PCIe cards and blank end-brackets, if needed.
- Replace the two screws securing the end-bracket retaining panel to Xpander rear.
- Replace the screws holding each of the end-brackets.
- Connect PCIe auxiliary (aux) power cables to the GPUs and the QSync card. Aux power connectors are located at the rear of each GPU or other QSync card. Rack Mount 2 provides two sets of 2 x 6-pin auxiliary power connectors. Xpander also provides 1 x SATA aux power cable for the QSync card, if needed.
- Replace the Xpander top cover and screws.
- Gently slide Xpander back in place.
- Secure Xpander into place within the cabinet using the front-panel screws provided. Use the Philips #2 screwdriver.
- Connect the PCIe x16 external cable to the HIC in the host computer.
- Connect power to Xpander.



Front Panel LCD

Xpander Rackmount 2 front panel LCD provides enclosure details and status. Beneath the LCD are two buttons: left button scrolls through main-menu and right button scrolls through sub-menu.



When you first connect power, Xpander comes up in standby mode. The LCD displays Cubix on the top line and Corporation on the bottom line. This is the Start menu. Access all other main menu items by pressing the left button.

The upper right corner of the LCD shows a flashing asterisk *. This indicates that the on-board Micro-Controller Unit (MCU) is running properly. If the asterisk is not flashing or the LCD is not responding, reset the MCU by pressing and holding the left button for 3 seconds. A corresponding HB (heartbeat) LED on the main board also shows the MCU is working.

When a fault occurs, the LCD will jump to that fault and the LCD backlight will flash on / off. Press the left button to acknowledge the fault and the LCD will stop flashing and enable normal operation. The LCD will continue to display the fault at the applicable sub-menu until you clear the fault.

Start Menu

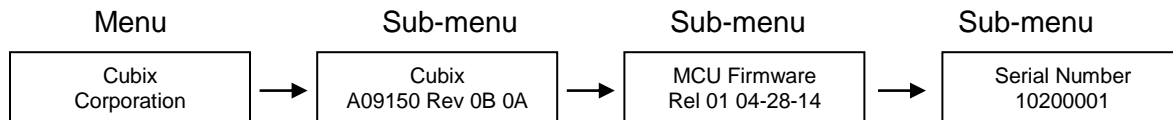

Main menu: Cubix Corporation

Sub-menu: PCB Assembly

- Board Number
- EEPROM Revision
- Board Revision

Sub-menu: MCU (Micro-Controller Unit) Firmware

- Release Number
- Release Date

Sub-menu: Cubix Serial Number

Power Supply Status

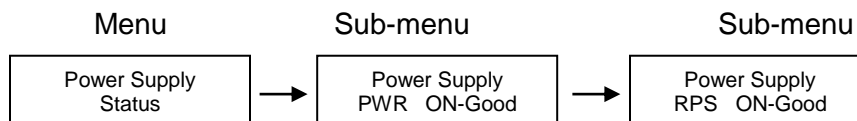

Menu: Power Supply Status

Sub-Menu: Power Supply Status:

- PWR Standby = Main power is off; system is in standby
- PWR ON-Good = Main power is on; +3.3V, +5V, +12V, -12V are within spec.
- PWR ON-FAULT = Main power is on; +3.3V, +5V, +12V, or -12V is out of spec.

Temperature Status

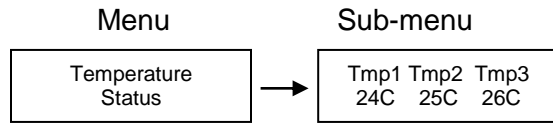

Menu: Temperature Status

Sub-Menu: Display the temperature of the 3 temperature sensors in degrees Celsius.

Note: If a temperature sensor fails, FLT (fault) appears under the failed sensor.

Fan Status

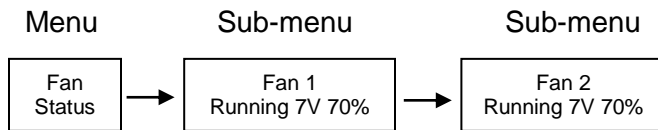

Menu: Fan Status

Sub-Menu: Indicates fan status for fans 1-2

Note: Fan speed is controlled by adjusting fan voltage based on sensed system temperature. Fan voltage adjusts from 6V min (25deg C or lower) at 50% to 12V max (50deg C or higher) at 100%. Fan voltage is the same for all fans.

Status: PWR OFF is 0V at 00%; system is in standby.

Status: Running aaV at pp%; fan is good; aa = fan voltage and pp = fan power percent (%).

Status: STOPPED is 12V at 100%; fan fault: fan voltage is set to full on.

Status: NO FAN aaV at pp%; Xpander can be configured with 1, 2, 3, or 4 fans. No fan means fan is not installed.

PCIe Link Status

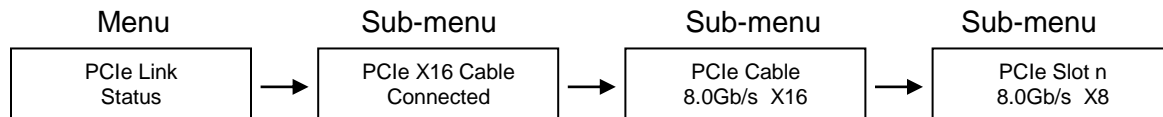

Menu: PCIe Link Status

Sub-Menu: Indicates x16 PCIe cable installation status

- Connected x16 cable is properly connected to the HIC
- NOT-Connected x16 cable is not properly connected to the HIC

Sub-Menu: x16 PCIe cable link speed and link width. Speed and width depend on the host capability.

- Speed: 8.0Gb/s
- Width: x1, x2, x4, x8, x16 and "NO Link" when the host did not successfully link or Xpander is in standby power.

Sub-Menu: Link speed and link width for slots 1-4.

- Speed: 8.0Gb/s
- Slot 1 - 4 width: x1, x2, x4, x8, and "NO Link" when the slot is empty, unsuccessful link, or Xpander is in standby power.

LCD Backlight Control

Press right button to toggle the LCD backlight On / Off.

Fan Speed Control

Shunts JP7 and JP8 are used to change the fan profile to reduce fan noise.

Fan Profile	JP8	JP7	*Tmax	*Tmin
Performance Mode		1-2	55C	20C
Quiet Mode	1-2		65C	30C
High Performance Mode		2-3	40C	5C
**GPU Mode	2-3	2-3	80C/40C	45C/5C

* Tmax - Fan Voltage ~12V, Tmin - Fan Voltage ~6V

**GPU Mode: Tmax: GPU temp = 80C, if no GPU is found Tmax = 40C (on-board temp sensors)
Tmin: GPU temp = 45C, if no GPU is found Tmin = 5C (on-board temp sensors)
GPUs supported: Quadro K6000, M6000 and P6000

Fan Profile Guidelines. GPU Mode supports 4 x double-wide GPUs like NVIDIA Quadro or GTX Series. High-Performance Mode supports 2 – 3 double-wide GPUs. and Performance Mode Performance Mode supports 2 x double-wide GPUs. Quiet Mode supports 1 x double-wide GPU or 4 x single-wide GPUs.

Shipping Procedure

Before shipping Xpander, remove any installed graphics or other controller(s) using the following procedure:

1. Switch off the host computer and disconnect power.
2. Disconnect Xpander from the HIC.
3. Gently pull Xpander toward you.
4. Lift Xpander down from the cabinet and set it on a stable surface.

Warning

Before lifting Xpander out of a cabinet, ask for assistance.

5. Remove the screws holding in place the Xpander front top cover, remove the top cover and set it aside.
6. Remove the screws holding each of the end-brackets.
7. Remove the two screws holding the end-bracket retaining panel from Xpander rear and remove the retaining panel.
8. Remove the GPUs and other PCIe cards and blank end-brackets.
9. Replace the two screws securing the end-bracket retaining panel to Xpander rear.
10. Replace the screws for holding each of the end-brackets.

Warning

Remove GPUs or other adapters before shipping Xpander.

11. Pack the graphics cards or other controllers within the boxes in which you received them.
12. Replace the Xpander front top cover, replace the screws and remove the power cords.
13. Remove the HIC(s) from the host computer.
14. Within the original packaging, pack the Xpander, the power cords, the HIC(s) and the boxed graphics cards. Include a copy of these instructions.

Troubleshooting Procedure

- Issue: The front-panel LCD asterisk does not flash.
Resolution: Reset the LCD's MCU by pressing and holding the left button for 3 seconds while Xpander is running.
- Issue: The HB LED inside Xpander flashes green.
Resolution: This is normal; it indicates that the on-board MCU is running properly.
- Issue: Cable LED inside Xpander does not light green.
Resolution: Check the following:
 - Confirm that the HIC is firmly seated in a PCIe slot within the host computer.
 - Confirm that the cable connector is firmly seated HIC connector port.
- Issue: Cable LED inside Xpander flashes green even though I have a PCIe x16 HIC and cable.
Resolution: The internal Cable LED should light steady green. If the Cable LED flashes, it is transferring data at a reduced bandwidth because you installed the PCIe x16 HIC in a Gen 1 slot or a PCIe x8 (electrical) slot. If your HIC is PCIe x8, you installed it in a Gen 1 slot. The HIC operates at full bandwidth when installed in a PCIe Gen 2 slot.
- Issue: Slot LED inside Xpander does not light green.
Resolution: Shut down the OS gracefully, power down Xpander and reseal the GPUs in each PCIe slot. Make sure that you seat each GPU firmly in its slot and that you connect all aux power connectors firmly.
- Issue: Slot LED inside Xpander flashes green even though I installed a PCIe x16 Gen 3 GPU or card.
Resolution: Slot LEDs should light steady green. If they are flashing, it may be because the GPUs in the slots do not have a processing load. Apply a processing load on the GPUs. If the slot LEDs still flash green, check the vendor's link for a driver update.
- Issue: All Cable and Slot LEDs are lit green, but your OS does not detect the GPUs.
Resolution: Shut down the OS gracefully, power down Xpander and reseal the GPUs in each PCIe slot. Make sure that you seat each GPU firmly in its slot and that you connect all aux power connectors firmly.
- Issue: The front-panel LCD screen backlight is flashing on/off, which indicates a fault.
Resolution: Acknowledge the fault by pressing the Menu button, which will stop the LCD flashing and the LCD will remain at the fault.
- Issue: After acknowledging a fault, the front-panel LCD screen backlight continues flashing on/off, which indicates two or more faults. If multiple faults have occurred, when you acknowledge the first fault, the LCD will jump to the next fault and the LCD backlight will once again flash on/off. This continues until you clear all faults.
Resolution: Acknowledge the fault by pressing the Menu button, which will either stop the LCD flashing and the LCD will remain at the fault, or the LCD will jump to the next fault and the LCD backlight will once again flash on/off.
- Issue: The front-panel LCD screen either does not respond or is blank even though Xpander is operating.

Resolution: Press and hold the MIB Select button to reset the Micro-Controller Unit (MCU).

Issue: The front-panel LCD screen either does not respond or is blank for a particular MIB even though Xpander and the MIB are both operating.

Resolution: Press and hold the Menu (left) button for 3 seconds to reset the Micro-Controller Unit (MCU). If the Xpander is running, the Xpander fans will turn on full speed for 10 seconds and then slow down to the operating speed set by the MIB local temperatures.