



CUBIX
Visualization and HPC Solutions

HostEngine 4U Host Computer User Guide

HostEngine 4U computer features Intel® Xeon® E5-2600v3 Series (Haswell) dual-processors with the Intel C612 chipset. HostEngine 4U provides four PCI Express (PCIe) Gen 3.0 x16 expansion slots. Each slot accommodates a full-height, full-length, double-wide GPU or a half-height, half-length controller such as the Cubix Host Interface Controller (HIC) that connects to Cubix Xpander products. Each HIC connects to multiple slots within an Xpander Rackmount 8 or other Xpander products.

By connecting HostEngine to GPU-Xpander Rackmount 8, you can add eight double-wide GPUs such as NVIDIA® Quadro M5000 or M6000 to the HostEngine 4U computer for running Autodesk® 3ds Max or Bunkspeed® Shot with NVIDIA iray running on Linux or Microsoft® Windows®. You can also run BlackMagic Design® DaVinci Resolve® for Linux on HostEngine 4U computer. Connecting to Xpander Rackmount 8 also enables you to connect to GPU Compute Engines such as NVIDIA or AMD GPUs for HPC applications, virtual desktop projects or multiple Intel Xeon Phi coprocessors for parallel processing.

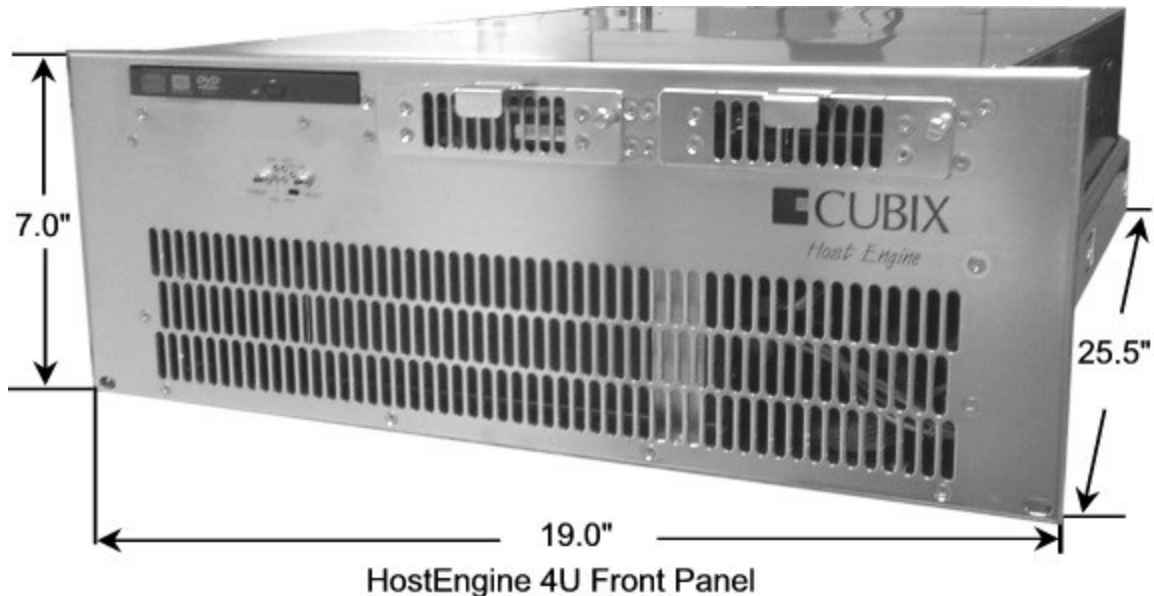

Technical Specifications

Central Processing Unit (CPU)	Intel® Xeon E5-2600v4 Series
Number CPUs	2 x R3 with identical revision, core voltage and bus (core) speed
Socket	2011-pin R3 LGA
Speeds / Cores / Threads	2.9GHz and lower / up to 18 cores / up to 36 threads
Intel Smart Cache	Up to 45MByte
64-bit computing	Yes
QuickPath Interconnect	Up to 9.6 GigaTransfers/second (GT/s) across 2 QPI links
Chipset	Intel C612
Front Side Bus Speed	2133MHz
System Memory Sizes	RDIMM: 32GByte, 16GByte, 8GByte or 4GByte LRDIMM: 64GByte or 32GByte
Type	Standard ECC Registered DIMMs (RDIMMs) Optional Load-Reduced DIMMs (LRDIMMs)
Configuration	DDR4-2400MHz, 1866MHz, 1600MHz, 1333MHz
Maximum Size	512GBytes using 16 x ECC Registered DIMMs (RDIMMs) 1TByte using 16 x Load-Reduced DIMMs (LRDIMMs)
PCI Express expansion slots	4x PCI-E 3.0 x16 2x PCI-E 3.0 x8 (1 in x16) 1x PCI-E 2.0 x4 (in x8)
System BIOS	AMI®
Ethernet ports (standard)	2 x Intel RJ-45 ports
Controller	Dual Intel i350 network controllers
Support	10BASE-T, 100BASE-TX, and 1000BASE-T
Ethernet port (management)	RJ-45 port for management only
Controller	Aspeed AST2400 BMC with dedicated IPMI
Support	10BASE-T, 100BASE-TX, and 1000BASE-T
Solid State Drive (SSD)	500GByte
Serial ATA (SATA)	4 x SATA 3 connectors
Drive Format	2.5-inch (63.5mm) solid-state drive (SSD)
Transfer Rate	6.0GByte / second (theoretical)
Number of drives / Capacity	1 standard or 2 optional
Graphics Controller	Aspeed AST2400 BMC
Audio Controller	High-Definition (HD) 7.1 with SPDIF-input digital header
Serial port	COM1 (DB-9)
Universal Serial Bus (USB)	Version 3.0
Ports	4: 2 x USB 3.0 and 2 x USB 2.0
AC Power Supply	One single-phase, auto-ranging, 90-240VAC, 10-5Amps, 50/60Hz; total output power is not to exceed 1,500Watts
Operating Environment	0° to 30° Celsius (32° to 86° Fahrenheit) temperature 5% to 80% non-condensing humidity
Altitude	Maximum
Operating	10,000ft (3,050meters)
Storage	50,000ft (15,240meters)
Dimensions	7.00" H x 19.00" W x 25.50" D (17.78 cm H x 48.26 W x 64.77CM D)
Weight	49.00 lbs. (24.50kg)
Warranty / Period	Parts & labor return to manufacturer / 2 year
Ext. Warranty Period	Optional 3 rd year

Memory Configuration

DIMM Configurations for CPU1 Only		
# DIMMs	Location	Memory Scheme
4	P1-DIMMA1 P1-DIMMB1 P1-DIMMC1 P1-DIMMD1	Interleaved DIMMs must be identical type and speed
8	P1-DIMMA1 P1-DIMMB1 P1-DIMMC1 P1-DIMMD1 P1-DIMMA2 P1-DIMMB2 P1-DIMMC2 P1-DIMMD2	
DIMM Configurations for CPU1 and CPU2		
16	P1-DIMMA1 P1-DIMMB1 P1-DIMMC1 P1-DIMMD1 P1-DIMMA2 P1-DIMMB2 P1-DIMMC2 P1-DIMMD2 P2-DIMME1 P2-DIMMF1 P2-DIMMG1 P2-DIMMH1 P2-DIMME2 P2-DIMMF2 P2-DIMMG2 P1-DIMMH2	Interleaved DIMMs must be identical type and speed

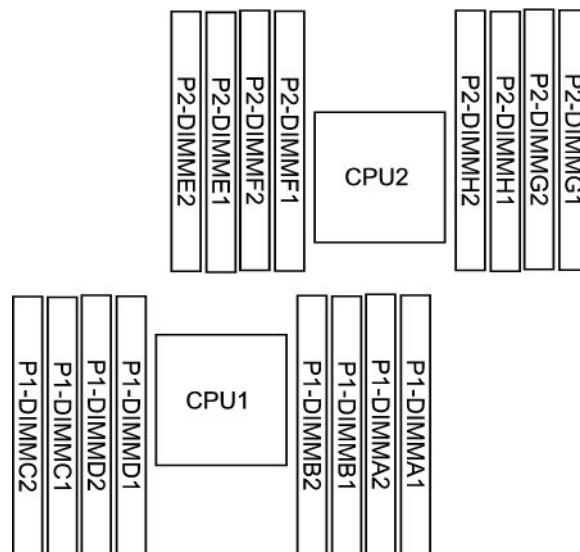

PCIe Gen 3 Slots

When installing a HIC in HE4U, make sure you seat it in one of the PCIe Gen 3 x16 slots, which are numbered CPU1 Slot2, CPU1 Slot 4, CPU2 Slot 6 and CPU2 Slot 8. For double-wide accelerators like NVIDIA Quadro Series or AMD Firepro W Series, use these four slots as well. If you add a single-wide display controller like AMD Firepro W2100 / W4100 or NVIDIA Quadro K4200 for connecting one or more 4K / UHD displays, and the PCIe Gen 3 x16 slots are occupied, use CPU1 Slot 10.

HostEngine 4U supports one to four 2.5-inch SATA 3 solid-state drives (SSDs) to boot the operating system (OS). HostEngine 4U also accommodates PCIe flash / SSDs. Install PCIe flash or SSD cards in CPU1 Slot 10 and / or CPU2 Slot 11, if available. See page 4 for details.

Access

Remove / Replace HostEngine

HostEngine can be removed and replaced from the front once you remove power.

- Power down gracefully using the OS or the front-panel on / off switch.

- Wait for the power to shut off.
- Disconnect power and all other cables from HostEngine.
- Loosen the two retention screws on the HostEngine front panel.
- Gently tug the HostEngine handles toward you.
- Extract the HostEngine while supporting its weight.
- Slide the replacement HostEngine into the rack mount slide mounts.
- Slide HostEngine into the cabinet.
- Replace and tighten the retention screws.
- Connect power and all other cables to HostEngine.
- Power up HostEngine.

Remove and replace PCIe devices

PCIe devices can be removed and replaced from the top once you power down HostEngine and remove the cop cover. See the image below for the PCIe devices to install in each slot.

- Power down gracefully using the OS and wait for the power to turn off
- Loosen the two retention screws on the HostEngine front panel.
- Gently tug the HostEngine handles toward you.
- Remove the screws holding the top cover and set it aside.
- Disconnect auxiliary power cables from the PCIe devices such as accelerators, if needed.
- Remove / replace the PCIe devices and re-connect the drive power and data cables.
- Replace the top cover and its retaining screws.
- Slide HostEngine into the cabinet.
- Replace and tighten the retention screws.
- Power up HostEngine.

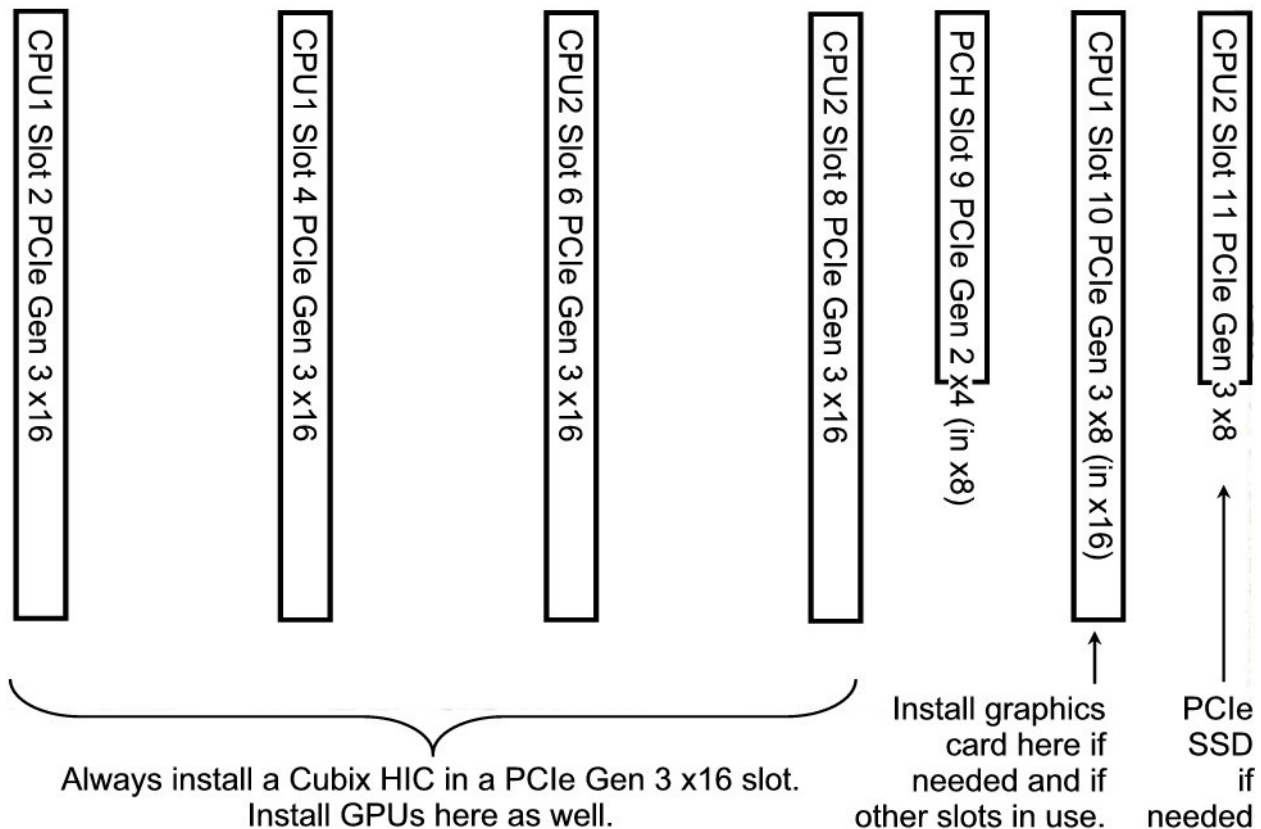

Remove and replace a SATA drive

SATA drives are removable from the front panel once you power down HostEngine.

- Power down gracefully using the OS or the power on/off button on HostEngine front panel and wait for the power LED to turn off
- Loosen the retention screw on the LaserBlade drive mounting bracket
- Gently tug the drive mounting bracket handle.
- Disconnect the drive power and data cables.
- Remove / replace the drive and re-connect the drive power and data cables.
- Slide in the drive mounting bracket and tighten the retention screw.

Note

Power down HostEngine before removing it or its hard disk drive.

Connections, Controls and Indicators

Connections

On the rear panel, HostEngine provides four USB 2.0 ports, two Gbps Ethernet ports, a COM port and an IPMI 2.0 GbE port. The AC power receptacle is also on the rear panel.

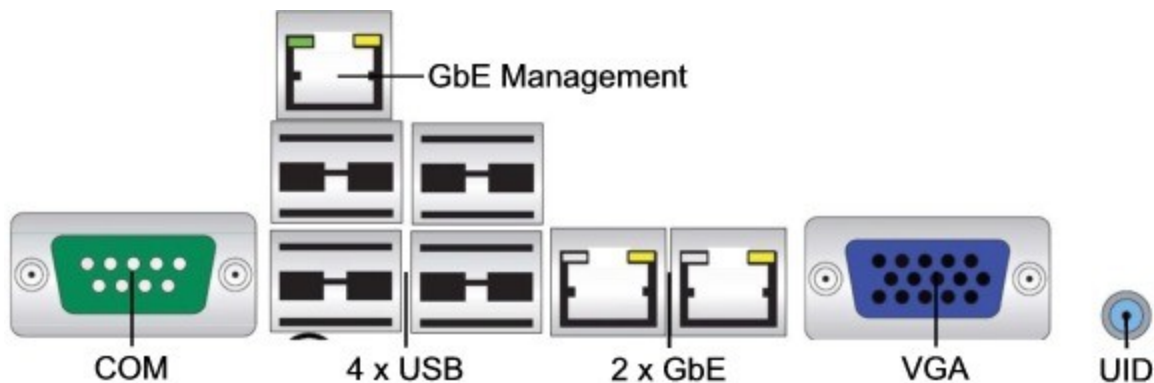

HostEngine also provides access for Cubix HICs that connect to GPU-Xpander Rackmount 8 or other Xpander enclosures using external PCIe x16 cables, if needed. With these connections, you can mount HostEngine immediately above or below GPU-Xpander Rackmount 8. You can also install PCIe cards inside HostEngine 4U. For example, install 4 x full-length, full-height, double-wide GPUs inside HostEngine 4U.

Controls

The front panel provides the power on/off button and the reset button. Pressing and releasing the power button during operation will provide a graceful shutdown of the operating system. Pressing and holding the power button for 4 seconds or more forces HostEngine to power off. See the image at the right.

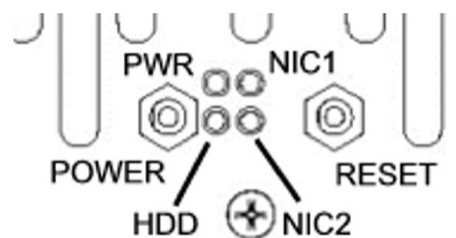

Indicators

Indicators (LEDs) for power (steady green), hard drive activity (flashing green), reset (flash green once), management (steady green) and identification (steady blue if enabled) are also on the front panel.

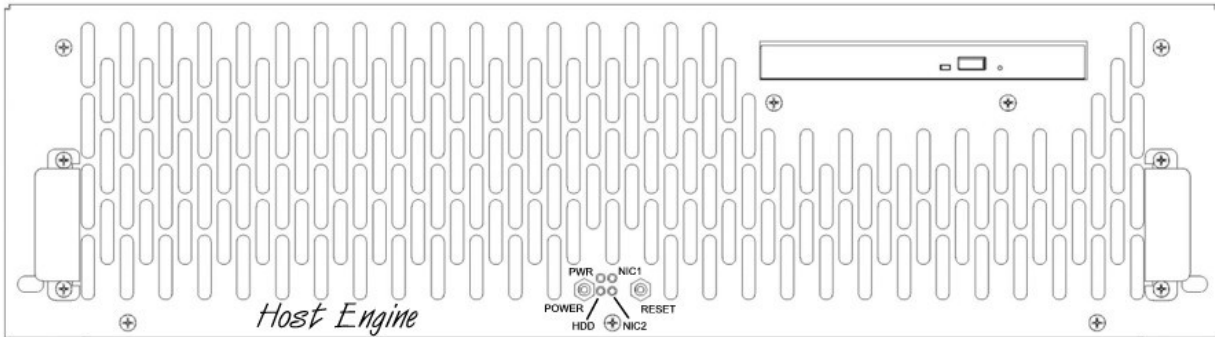

Install HostEngine in a Rack Mount Cabinet

Cubix ships HostEngine with the slide mounts installed on the enclosure.



Cubix ships the slide mounts mounted on the HostEngine enclosure.

Within packaging, you will find four brackets that mount within your rack mount cabinet as well as screws, nuts and G-nuts for use in mounting HostEngine. See the image at right.

Mount HostEngine close enough to GPU-Xpander Rack Mount 8 so that the standard 2meter cables will reach. Mount GPU-Xpander Rack Mount 8 enclosure immediately above or immediately below HostEngine in the rack mount cabinet. For this procedure, use a Philips #2 screwdriver, a flat-blade screwdriver and a 3/8" wrench or socket and drive.

1. Shut down HostEngine normally.
2. Disconnect all data and power cables.
3. Remove the two slide mounts—one slide mount from each side of the HostEngine enclosure. To release each slide mount, slide it toward the rear of the enclosure until it stops. Press the catch to release and remove the slide mount as you can see in the image at the right.

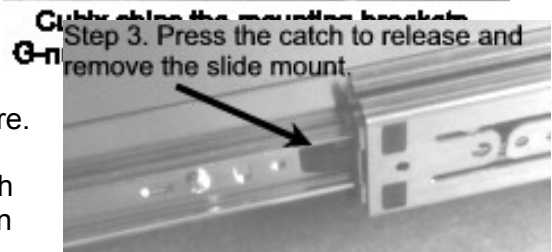
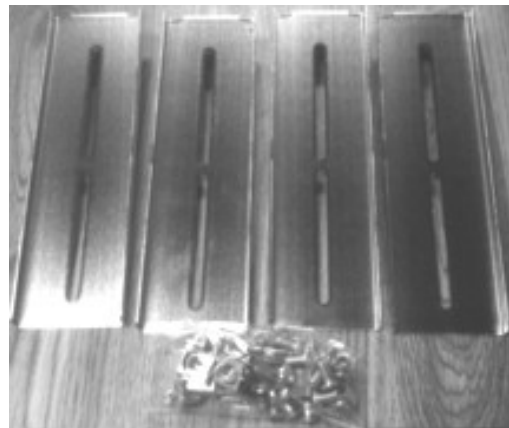

4. Mount the HostEngine mounting brackets and slide mounts in your cabinet. Allow vertical space for 2U or 4U as appropriate for your enclosure.
5. Mount the front and rear mounting brackets in the left side of your cabinet. Make sure all four line up so that HostEngine is level within the cabinet. See the image at the right.
6. Mount each of the two sliders into the front and rear mounting brackets (Part # S18500A) and slider assembly with the bolts and G-nuts provided in the packaging. Use the Philips #2 screwdriver and the 3/8" wrench or socket to secure snugly but not tightly each slider to the front and rear mounting brackets. Check to make sure the mounting brackets and slide rails are level from front to rear before tightening the screws and nuts. Align the front of the slider with the front of the cabinet.
7. Repeat the process for the other two front and two rear mounting brackets and slider assembly on the right side of the cabinet.
8. Check to make sure that the slide rails are level, both from front to back and from right to left. Once you're sure the slide rails are level, you're ready to tighten the mounting screws. See the image at the right.
9. Tightly secure the screws holding the sliders to the front and two rear mounting brackets on each side of the cabinet.
10. Extend the slide rails almost all the way out the front of the cabinet.
11. Lift the HostEngine, line it up carefully and slide it into place. Before lifting the HostEngine into place, ask for assistance.

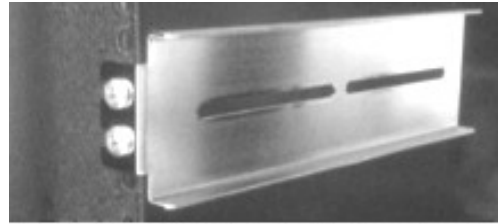

Step 5. Mount the brackets in 4 corners.



Step 8. Mount the slide rails on the mounting brackets (inside view).

Warning

Before you lift a HostEngine into place, ask for assistance.

12. Try sliding the HostEngine in and out slightly to make sure it moves freely.
13. Connect the AC power cords into the HostEngine rear receptacle.
14. Connect the PCIe x16 external cables to GPU-Xpander Rack Mount 8.
15. Power up HostEngine.